

Guyer Art Barn



Town of Barnstable ADA Transition Plan

July 2021



Institute for Human Centered Design

200 Portland Street, Boston, MA 02114
www.IHCDesign.org • info@IHCDesign.org
617-695-1225 voice/ tty

Background

The Guyer Art Barn is located at 250 South Street in Hyannis. The Guyer Barn is a community art space, working artist-in-residence, arts studio and art gallery open year-round. Programs include art classes, workshops and performances. The Guyer Barn is part of the HyArts Campus of Town's owned properties.

The building consists of a ground level plus a mezzanine connected by a staircase. The accessible entrance/exit is located on the south side of the building. Amenities include a main hall, and a single-user toilet room on the first floor. The mezzanine level is not open to the public. The parking lot is located on the east side of the building. There are six (6) parking spaces including a van accessible parking space.

Key Accessibility Issues

- Excessive running slope at the walkway leading to the main entrance.
- Picnic table not accessible (with knee and toe clearance) and not located on an accessible route.
- Excessive running slope at the maneuvering clearance at the main entrance.
- Egress sign not provided at the accessible egress.
- Designation sign at the toilet room not compliant and not located on the lath side of the door.
- Accessibility issues at the single-user toilet room include:
 - Flush control not located on the open/transfer side.
 - Lack of clear floor space at the toilet due to the location of furniture.
 - Lack of insulated pipes at the lavatory.

Order of Magnitude Cost Estimates

- Provide a compliant accessible route: \$1,200
- Provide a compliant picnic table: \$1,400
- Miscellaneous corrective actions (signage, toilet room, etc.): \$1,480

Total: \$4,080



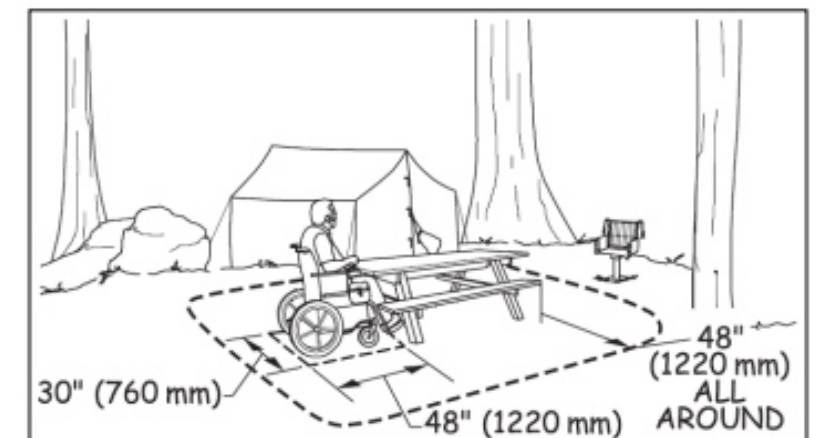

Best Practice and Inclusive Design

Best practice and inclusive design recommendations include elements that are not required in the standards but may create enhanced experiences for all users.





- Recommends providing 48" wide stable, firm and slip-resistant surface all around the picnic table.

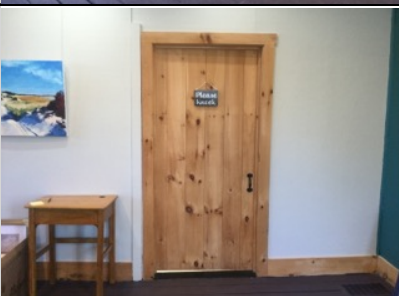

**Town of Barnstable
Guyer Art Barn**

| ID | Location | Floor | Room | Element | Type | Photo | Issues | Current Measure | Recommendations | Quantity | Price | Cost Estimation |
|----|-------------------------|-------|------|-----------------------|---------------|--|---|-----------------|--|----------|-------|-----------------|
| 1 | Main Entrance/ Exit | Ext. | | Exterior Access Route | Walkway |  | Running slope > 1:20 (5%) | 12.7% | Reduce running slope to be no steeper than 1:20 (5.00%). (Cost for adding concrete to correct pathway running slope.) | 1 | 1200 | \$1200 |
| 2 | Main Entrance/ Exit | Ext. | | Entrance | Main Entrance |  | Maneuvering clearance at door > 1:50 (2.00%) | 8.6% | Alter so that the slope in all directions is no greater than 1:50 (2.00%). (Cost for adding concrete to correct maneuvering clearance at the door.) | 1 | 400 | \$400 |
| 3 | Main Entrance/ Exit | 1 | | Means of Egress | N/A |  | Tactile exit sign not provided | - | Ensure tactile exit signs with raised characters and braille are provided at exit doors. Mount signs between 48" - 60" above the finished floor located on the latch side of the door. If an illuminated exit sign is provided, ensure that the sign has an illuminated sign with the International Symbol of Accessibility (ISA). | 1 | 232 | \$232 |
| 4 | Main Hall | 1 | | Swimming Pool | |  | | | If tables are kept there, ensure an accessible work surface with at least 27" knee clearance is provided | 1 | - | \$0 |
| 5 | Single-User Toilet Room | 1 | | Signage | Designation |  | Raised characters not provided on sign Raised characters < 48" or > 60" above ground Sign not located on the latch side of the door | | Provide text with raised characters duplicated in braille on sign. Mount sign so that the baseline of the lowest tactile character is 48" min. above finished floor and the baseline of the highest tactile character is 60" max. above the finished floor. Locate sign at permanent rooms alongside the door on the latch side. | 1 | 232 | \$232 |

**Town of Barnstable
Guyer Art Barn**

| ID | Location | Floor | Room | Element | Type | Photo | Issues | Current Measure | Recommendations | Quantity | Price | Cost Estimation |
|----|-------------------------|-------|------|--------------------|------|--|---|---------------------|---|----------|-------|-----------------|
| 6 | Single-User Toilet Room | 1 | | Single-User Toilet | N/A |  | Flush control not on open side Clearance at toilet < 60" clear width | - - | Relocate the flush control to the open side. Remove table to maintain the required 60" wide min. clear floor space at the toilet. | 1 | 374 | \$374 |
| 7 | Single-User Toilet Room | 1 | | Lavatory | N/A |  | Plumbing underneath is exposed | - | Insulate or otherwise configure pipes to prevent contact at lavatory. | 1 | 92 | \$92 |
| 8 | Single-User Toilet Room | 1 | | Single-User Toilet | |  | Hook located > 48" high | 71.5" | Locate hook no higher than 48" above the finished floor. | 1 | 150 | \$150 |
| 9 | Near Parking | Ext. | | Picnic Tables | N/A |  | Top of dining/work surfaces < 28" or > 34" Toe or knee clearance at tables not provided Picnic table not on an accessible route | 25.6" 24.1" - | Provide at least one picnic table with top between 28"- 34" above the ground and 27" clear height underneath. Ensure the picnic table is connected to an accessible route. | 1 | 1400 | \$1400 |