

Sea Street Bathhouse and Keyes Memorial Beach



ADA Transition Plan

September 2021



Institute for Human Centered Design

www.IHCDesign.org • info@IHCDesign.org
617-695-1225 voice/ tty

Background

Sea Street Bathhouse and Keyes Memorial Beach is located at 108 Ocean Avenue. Amenities in the area include a picnic area, a viewing area, a bathhouse, a beach volleyball area, an outdoor shower and a parking lot. There is a wheelchair beach at this location.

There are two (2) routes to the bathhouse. One (1) route leads from the parking lot to the bathhouse (west side) - this route includes a ramp and a walkway. A second route leads from Sea Street to the bath house (east side). Two (2) ramps on both sides of the bathhouse (north and south sides) provide an accessible route to the toilet rooms. There are several entry points to the beach. There is one (1) entry point from the parking lot (south side) and two (2) additional entry points via stairs (south of the bathhouse). The parking lot has 132 parking spaces including five (5) accessible parking spaces.

The bathhouse is located on the north side of the beach and consists of a men's toilet room, a women's toilet room and an outdoor shower. The men's toilet room has one (1) accessible toilet compartment, two (2) urinals including one (1) accessible urinal and two (2) changing rooms. The women's toilet room has two (2) toilet compartments including one (1) that is accessible, and three (3) changing rooms. The outdoor rinsing shower is located on the southeast corner of the bathhouse.

Key Accessibility Issues

Exterior Accessible Routes

Accessibility issues include walkways with running slopes that are greater than the maximum allowed and that also are not maintained in operable working condition, (surfaces have cracks and potholes). Other accessibility issues include lack of an accessible route to the amenities in the area (viewing area, picnic tables and grills), noncompliant handrails at the ramp leading to the bathhouse from the parking lot and lack of edge protection at all the ramps.

Beach Access

Accessibility issues include lack of an accessible route to the high tide level, and an excessive change in level at the entrance to the beach from the parking lot.

Parking Lot

Accessibility issues include parking lot not maintained in operable working condition, lack of access aisles at the designated parking spaces and lack of the designation "Van Accessible" at one of the identification signs.

Bathhouse

Accessibility issues at the toilet rooms include lack of insulated pipes at the lavatories, toilet paper dispensers mounted above the side grab bars, coat hooks mounted higher than the maximum height allowed and dispensers that protrude into the circulation path. There is also a lack of an accessible portable toilet.

Accessibility issues at the changing rooms include lack of compliant changing rooms including lack of a turning space, lack of a clear floor space adjacent to the bench and coat hooks higher than the maximum allowed. See Fig. 1 at the end of this report for an example of an accessible changing room.

Also, the outdoor rinsing shower is not located on an accessible route, lacks a clear floor space, lacks compliant controls and lacks a lower shower head. See Fig. 2 at the end of this report for an example of an accessible outdoor rising shower.

Additional Accessibility Issues

- Lack of an accessible service counter (east side).
- Lack of designation signage (women's toilet room).
- Lack of accessible picnic tables.

Note: The picnic area has newer picnic tables but they lack the required 19" knee clearance. See fig. below.

Sea Street Bathhouse and Keyes Memorial Beach

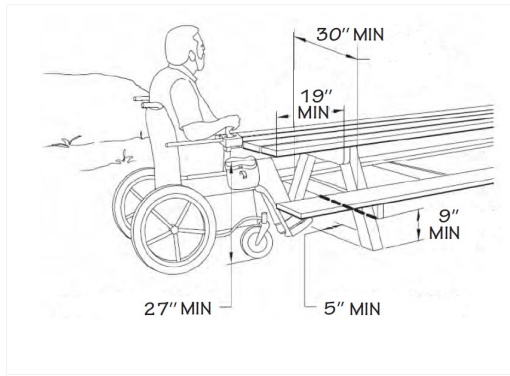

- Renovate ramps: \$10,200
- Provide an accessible route to the beach and volleyball area (beach mats): \$8,777
- Renovate toilet and changing rooms: \$15,847
- Miscellaneous corrective actions (signage, service counter, picnic tables, etc.): \$5,352

Total: \$40,176*

***Note:** Cost to provide compliant walkways are not included. Cost to restripe the parking lot is not included. Only the cost to provide access aisles at the accessible parking spaces and a sign with the designation “Van Accessible” is included as it relates to the costs necessary to renovate the accessible parking. Cost to provide a compliant accessible portable toilet is not included.

Best Practice and Inclusive Design

Best practice and inclusive design recommendations include elements that are not required in the standards but may create enhanced experiences for all users.

- Recommend providing some benches with backs and some with arms at the viewing area (southwest side of the bathhouse).
- Recommend providing a 36" by 48" clear floor space adjacent to the benches located near the staircases (routes to Beach Access 1 and 2. See Fig. 3).
- Recommend providing a directional sign at the route leading to the viewing area directing members of the public to the

accessible route. Locate sign at the beginning of the route to minimize backtracking.

- Recommend changing the sign located near the toilet rooms (employee office side) with a sign that reads "Accessible Toilet Rooms".
- Recommend providing a sign that reads "No Parking Any Time" at the entrance to the ramp leading to the bathhouse to maintain clear space at the accessible route to the bathhouse and other amenities in the area.
- Recommend providing closed risers at the stairs (southwest side).
- Recommend providing 48" wide stable, firm and slip-resistant surface all around the accessible picnic table.

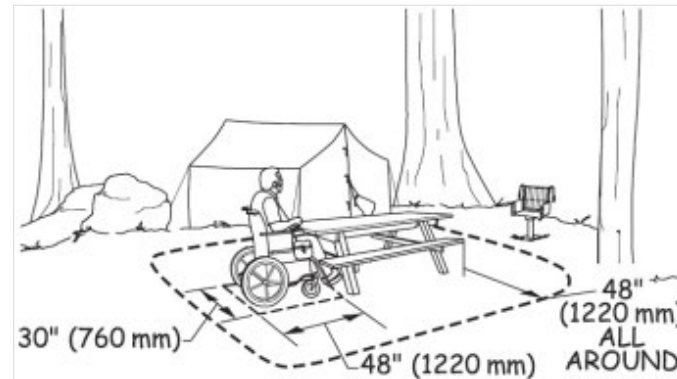

- Recommend providing 48" wide stable, firm and slip-resistant surface all around the grilles.

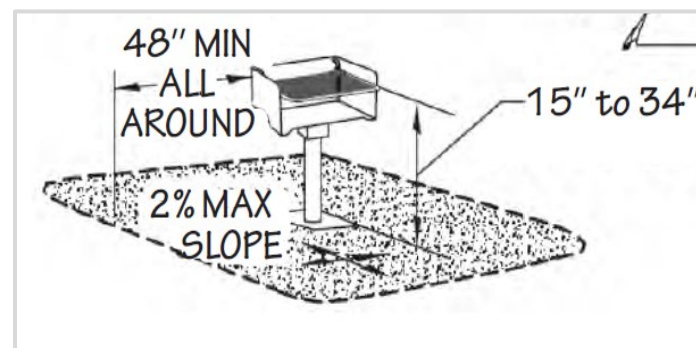

Fig. 1 Accessible Changing Room

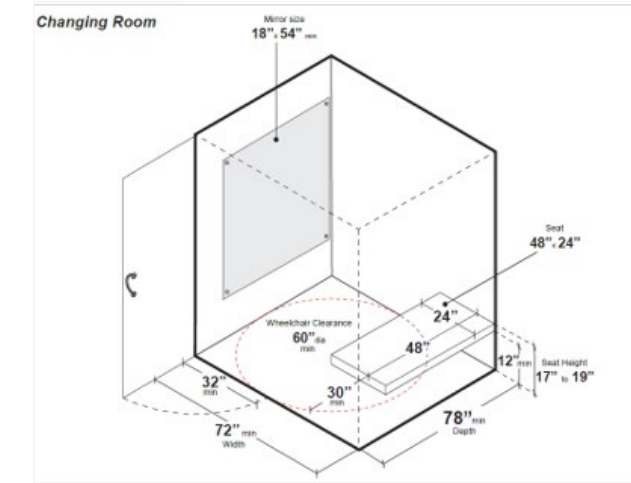

Fig. 2 Accessible Rinsing Shower

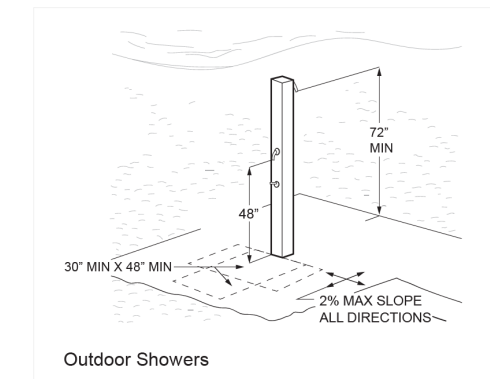







Fig. 3 Illustration showing the Beach Access Path to the Viewing Area







Town of Barnstable
Sea Street Bathhouse and Keyes Memorial Beach

ID	Location	Floor	Room	Element	Type	Photo	Issues	Current Measure	Recommendations	Quantity	Price	Cost Estimation
Approach and Entrance												
Exterior Access Route												
1	Route From Parking Lot to Bathhouse	Ext.		Exterior Access Route	Walkway		Cross slope > 1:50 (2.00%)	7%	Reduce cross slope to be no steeper than 1:50 (2.00%).	1	-	\$0
2	Route to Bathhouse	Ext.		Exterior Access Route	Walkway		Cross slope > 1:50 (2.00%)	4.7%	Reduce cross slope to be no steeper than 1:50 (2.00%).	1	-	\$0
3	Route From Parking Lot to Bathhouse	Ext.		Exterior Access Route	Walkway		Running slope > 1:20 (5%)	7.6%	Reduce running slope to be no steeper than 1:20 (5.00%).	1	-	\$0
4	Route From Parking Lot to Bathhouse	Ext.		Exterior Access Route	Sidewalk		Running slope > 1:20 (5%)	10%	Reduce running slope to be no steeper than 1:20 (5.00%).	1	-	\$0
5	Route From Parking Lot to Bathhouse	Ext.		Exterior Access Route	Sidewalk		Running slope > 1:20 (5%)	8.5%	Reduce running slope to be no steeper than 1:20 (5.00%).	1	-	\$0





**Town of Barnstable
Sea Street Bathhouse and Keyes Memorial Beach**

ID	Location	Floor	Room	Element	Type	Photo	Issues	Current Measure	Recommendations	Quantity	Price	Cost Estimation
6	Route to Viewing Area	Ext.		Exterior Access Route	Exterior		Surface is not stable, firm, and slip-resistant Route not maintained in operable working condition	- -	Repair surface. Ensure the accessible route is maintained in operable working condition.	1	-	\$0
7	Route From Sea Street Extension to Bathhouse	Ext.		Exterior Access Route	Walkway		Route not maintained in operable working condition	-	Ensure the accessible route is maintained in operable working condition.	1	Labor	\$0
8	Towards Beach	Ext.		Exterior Access Route	Exterior		Accessible route not provided	-	Provide an accessible route to the volleyball area. See ID #9.	1	-	\$0
Beach Access Routes												
9	Towards Beach	Ext.		Beach Access Routes	Removable		Beach route not provided	-	Provide an accessible route that is firm and stable. Ensure the accessible route extends to the high tide level. Cost for a 5 ft wide by 100 ft. long beach mat.	1	8777	\$8777
10	Route From Parking Lot to Beach	Ext.		Beach Access Routes	N/A		Surface is not firm and stable	-	Ensure surface at the accessible route is firm and stable.	1	Labor	\$0



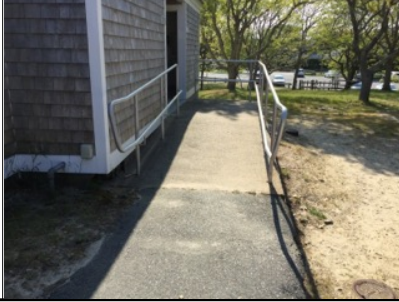

**Town of Barnstable
Sea Street Bathhouse and Keyes Memorial Beach**

ID	Location	Floor	Room	Element	Type	Photo	Issues	Current Measure	Recommendations	Quantity	Price	Cost Estimation
11	Route From Parking Lot to Beach	Ext.		Beach Access Routes	N/A		Level changes > 1/4"	5.5"	Ensure change in level is not greater than 1/4" high max.	1	Labor	\$0
Off-Street Parking Lot or Garage												
12	Parking Lot	Ext.		Off-Street Parking Lot or Garage	N/A		Access aisle not provided Sign does not have the designation "Van Accessible"	- - -	Provide three marked access aisles that are at least 96" wide. Add the designation "Van Accessible" to the sign located at the van accessible space.	1	1400	\$1400
Access to Goods and Services												
Ramps												
13	Route From Parking Lot to Bathhouse	Ext.		Ramps	Exterior		Handrails have non-compliant cross section Edge protection < 4" high	- -	Provide handrails with 1-1/4" to 1-1/2" circular cross section. Ensure handrails return to to the landing surface. Provide edge protection that prevents the passage of a 4" diameter sphere, where any portion of the sphere is within 4" of the finished ground surface.	1	5160	\$5160
14	Ramp by Parking Lot	Ext.		Ramps	Exterior		Landing has a slope > 1:50 (2.00%) (MAAB)	-	Alter so that the slope in all directions is no greater than 1:50 (2.00%).	1	-	\$0
15	Ramp - Employee's Office Side	Ext.		Ramps	Exterior		Edge protection < 4" high	-	Provide edge protection that prevents the passage of a 4" diameter sphere, where any portion of the sphere is within 4" of the finished floor or ground surface.	1	2520	\$2520





**Town of Barnstable
Sea Street Bathhouse and Keyes Memorial Beach**

ID	Location	Floor	Room	Element	Type	Photo	Issues	Current Measure	Recommendations	Quantity	Price	Cost Estimation
16	Ramp -Toilet Rooms Side	Ext.		Ramps	Exterior		Edge protection < 4" high	-	Provide edge protection that prevents the passage of a 4" diameter sphere, where any portion of the sphere is within 4" of the finished floor or ground surface.	1	2520	\$2520
Signage												
17	Women's Toilet Room	1		Signage	Designation		Raised characters not provided Braille not provided Sign not located on the latch side of the door	- - -	Provide text with raised characters duplicated in braille. Locate sign at permanent rooms alongside the door on the latch side.	1	232	\$232
Service Counter												
18	Bathhouse - Sea Street Side	Ext.		Service Counter	N/A		Counter > 36" high	42.75"	Provide a counter that is 36" max. above the ground.	1	880	\$880
Picnic Tables												
19	Picnic Area /next to Employee's Side Ramp	Ext.		Picnic Tables	N/A		Toe or knee clearance at table not provided Picnic table not on an accessible route	- -	Provide at least one picnic table with top between 28"- 34" above the ground and 27" clear height underneath. Ensure that the dining surface is connected to an accessible route.	1	1400	\$1400
20	Picnic Area Next to Ramp by Toilet Rooms	Ext.		Picnic Tables	N/A		Toe or knee clearance at table not provided Picnic table not on an accessible route	- -	Provide at least one picnic table with top between 28"- 34" above the ground and 27" clear height underneath. Ensure that the dining surface is connected to an accessible route.	1	1400	\$1400





**Town of Barnstable
Sea Street Bathhouse and Keyes Memorial Beach**

ID	Location	Floor	Room	Element	Type	Photo	Issues	Current Measure	Recommendations	Quantity	Price	Cost Estimation
Grills												
21	Picnic Area	Ext.		Grills	N/A		Not on a accessible route	-	Ensure grills are located on an accessible route.	1	Labor	\$0
Toilet & Bathing Rooms												
Lavatory												
22	Women's Toilet Room	1		Lavatory	N/A		Exposed plumbing underneath	-	Insulate or otherwise configure pipes to prevent contact for at least one lavatory.	1	92	\$92
23	Men's Toilet Room	1		Lavatory	N/A		Exposed plumbing underneath	-	Insulate or otherwise configure pipes to prevent contact for at least one lavatory.	1	92	\$92
Toilet Compartment												
24	Women's Toilet Room	1		Toilet Compartment	Accessible Compartment		Non-compliant toilet paper dispenser	-	Relocate toilet paper so that it is located under the grab bar and higher than 15" above the finished floor; and between 7" and 9" from the front of the toilet. Or replace dispenser if it does not allow continuous paper flow.	1	256	\$256





**Town of Barnstable
Sea Street Bathhouse and Keyes Memorial Beach**

ID	Location	Floor	Room	Element	Type	Photo	Issues	Current Measure	Recommendations	Quantity	Price	Cost Estimation
25	Men's Toilet Room	1		Toilet Compartment	Accessible Compartment		Non-compliant toilet paper dispenser	- 20"	Relocate toilet paper so that it is located under the grab bar and higher than 15" above the finished floor; and between 7" and 9" from the front of the toilet. Or replace dispenser if it does not allow continuous paper flow.	1	256	\$256
26	Men's Toilet Room	1		Toilet Compartment	Accessible Compartment		Coat hook > 48"	61.5"	Lower coat hook so that it is no higher than 48".	1	150	\$150
27	Women's Toilet Room	1		Toilet Compartment	Accessible Compartment		Coat hook > 48"	65.25"	Lower coat hook so that it is no higher than 48".	1	150	\$150
Dispensers												
28	Men's Toilet Room	1		Dispensers	N/A		Dispenser acts as a protruding object	-	Relocate dispenser so it does not protrude into the circulation path.	1	Labor	\$0
29	Women's Toilet Room	1		Dispensers	N/A		Dispenser acts as a protruding object	-	Relocate dispenser so it does not protrude into the circulation path.	1	Labor	\$0



**Town of Barnstable
Sea Street Bathhouse and Keyes Memorial Beach**

ID	Location	Floor	Room	Element	Type	Photo	Issues	Current Measure	Recommendations	Quantity	Price	Cost Estimation
Outdoor Rinsing Showers												
30	Path to Outdoor Shower	Ext.		Outdoor Rinsing Showers	N/A		Rinsing shower not on an accessible route	- -	Provide an accessible route to the rinsing shower or locate a new rinsing shower on an accessible route.	1	-	\$0
31	Outdoor Shower	Ext.		Outdoor Rinsing Showers	N/A		Clear floor space not provided at rinsing shower 2 fixed shower heads not provided	- -	Ensure there is a 60" by 60" clear floor space around outdoor rinsing shower.	1	3119	\$3119
Portable Toilet												
32	By Parking Lot	Ext.		Portable Toilet	N/A		Accessible portable toilets not provided	-	Provide an accessible portable toilet.	1		\$0
Changing Room												
33	Men's Changing Room	1		Changing Room	515		Room is < 78" x 72"	58.5"x45.5"	Provide an accessible changing room that is 78" by 72" minimum.	1	5866	\$5866
34	Women's Changing Room	1		Changing Room	516		Room is < 78" x 72"	-	Provide an accessible changing room that is 78" by 72" minimum.	1	5866	\$5866

**Town of Barnstable
Sea Street Bathhouse and Keyes Memorial Beach**

ID	Location	Floor	Room	Element	Type	Photo	Issues	Current Measure	Recommendations	Quantity	Price	Cost Estimation
Best Practice												
Benches												
35	Stair Beach Access 1	Ext.		Benches	N/A				Recommend providing a 36" by 48" clear floor space adjacent to the bench.	1	-	\$0
36	Stair Beach Access 2	Ext.		Benches	N/A				Recommend providing a 36" by 48" clear floor space adjacent to the bench.	1	-	\$0
37	Viewing Area	Ext.		Benches	N/A				Recommend providing some benches with backs and some with arms.	1	-	\$0
Directional Signage												
38	Path From Bathhouse to Stair Beach Access 1	Ext.		Directional Signage	N/A				Recommend providing a directional sign to the accessible route. Locate sign at the beginning of the route to minimize backtracking.	1	-	\$0
39	Path From Beach Access 1 to Beach Access Stairs 2	Ext.		Directional Signage	N/A				Recommend providing a directional sign to the accessible route. Locate sign at the beginning of the route to minimize backtracking.	1	-	\$0

**Town of Barnstable
Sea Street Bathhouse and Keyes Memorial Beach**

ID	Location	Floor	Room	Element	Type	Photo	Issues	Current Measure	Recommendations	Quantity	Price	Cost Estimation
40	Ramp - Employee's Office Side	Ext.		Directional Signage	N/A				Recommend changing the sign with a sign that reads "Accessible Toilet Rooms".	1	-	\$0
Signage												
41	Parking Lot	Ext.		Signage	N/A				Recommend providing a sign that reads "No Parking Any Time" to maintain clear space at the accessible route to the bathhouse and other amenities in the area.	1	-	\$0
Stairs												
42	Staircase by Parking Lot			Stairs	N/A				Recommend providing closed risers at the stairs.	1	-	\$0